

769-632

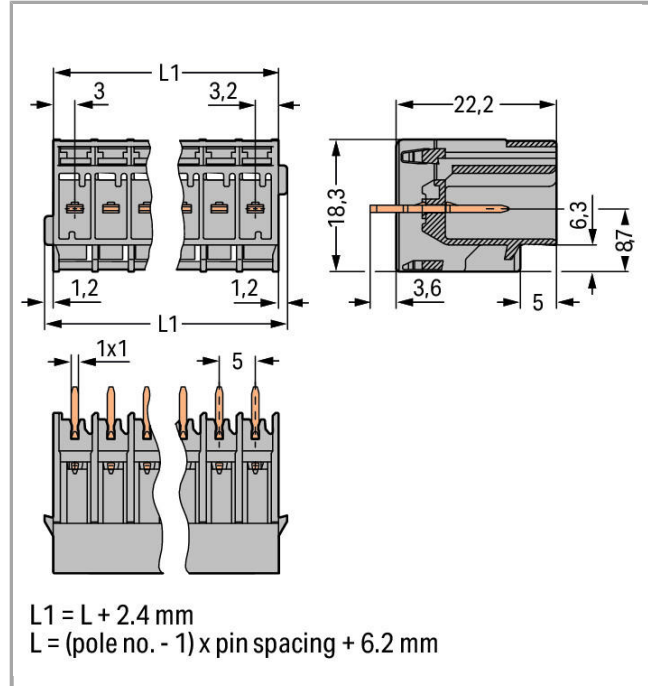

RoHS Compliant

[BOMcheck.net](https://www.bomcheck.net)

Color: ■

Data

Electrical data

Ratings per IEC/EN 60664-1

Rated voltage (III / 3)	250 V
Rated impulse voltage (III / 3)	4 kV
Rated voltage (III / 2)	500 V
Rated impulse voltage (III / 2)	4 kV
Rated current	32 A

Connection data

No. of poles	2
Total number of potentials	2

Number of levels	1
------------------	---

Geometrical Data

Pin spacing	5 mm / 0.197 inch
Width	13.6 mm / 0.535 inch
Height from the surface	22.2 mm / 0.874 inch
Depth	18.3 mm / 0.72 inch

Plug connection

Contact type (pluggable connector)	Male connector/plug
Connector connection type	for PCBs
Mismating protection	No
Mating direction to the PCB	90°

PCB contact

PCB contact	THT
-------------	-----

Material Data



Color	gray
Insulating material	Polyamide 66 (PA 66)
Fire load	0.055 MJ
Weight	2.434 g



Commercial data

Product Group	18 (X-COM-System)
Country of origin	DE
GTIN	4044918270564
Customs Tariff No.	85366990990



Approvals / Certificates

Country specific Approvals

Logo	Approval	Additional Approval Text	Certificate name
	CCA DEKRA Certification B.V.	EN 60947	NTR NL- 7626
	CCA DEKRA Certification B.V.	EN 61984	2190419.02

	CCA DEKRA Certification B.V.	IEC 61984	NL-47799
	CSA DEKRA Certification B.V.	C22.2 No. 158	1101144
	KEMA/KEUR DEKRA Certification B.V.	EN 60947	2190419.01

UL-Approvals

Logo	Approval	Additional Approval Text	Certificate name
	UR Underwriters Laboratories Inc.	UL 1977	E45171
	UR Underwriters Laboratories Inc.	UL 1059	E45172

Compatible products

Female plug

	Item no.: 769-101 1-conductor female plug; 4 mm ² ; 1-pole		769-101
	Item no.: 769-102 1-conductor female plug; 4 mm ² ; 2-pole		769-102
	Item no.: 769-102/000-036 1-conductor female plug; 4 mm ² ; 2-pole	/000-036	769-102
	Item no.: 769-102/000-037 1-conductor female plug; 4 mm ² ; 2-pole	/000-037	769-102
	Item no.: 769-102/021-000 1-conductor female plug; Locking lever; 4 mm ² ; 2-pole	/021-000	769-102
	Item no.: 769-121 2-conductor female connector; 4 mm ² ; 1-pole		769-121
	Item no.: 769-122 2-conductor female connector; 4 mm ² ; 2-pole		769-122

Coding

	Item no.: 769-435 Coding pin; for coding of female plugs; for carrier terminal blocks / male connectors	769-435
--	---	---------

Marking accessories

	Item no.: 210-831 Marking strips; on reel; 2.3 mm wide; plain; Self-adhesive	210-831
	Item no.: 210-832 Marking strips; on reel; 3 mm wide; plain; Self-adhesive	210-832
	Item no.: 210-833 Marking strips; on reel; 6 mm wide; plain; Self-adhesive	210-833
	Item no.: 210-834 Marking strips; on reel; 5 mm wide; plain; Self-adhesive	210-834

Downloads

Documentation

Bid Text

769-632	doc 25.1 kB	Download
---------	----------------	----------

CAD/CAE - Smart Data

CAD data

3D Download 769-632	URL	Download
---------------------	-----	----------

Product family

X-COM

[Learn more about the product family.](#)

[Show all products from the family](#)

Subject to changes.